

6-input Load cell junction box

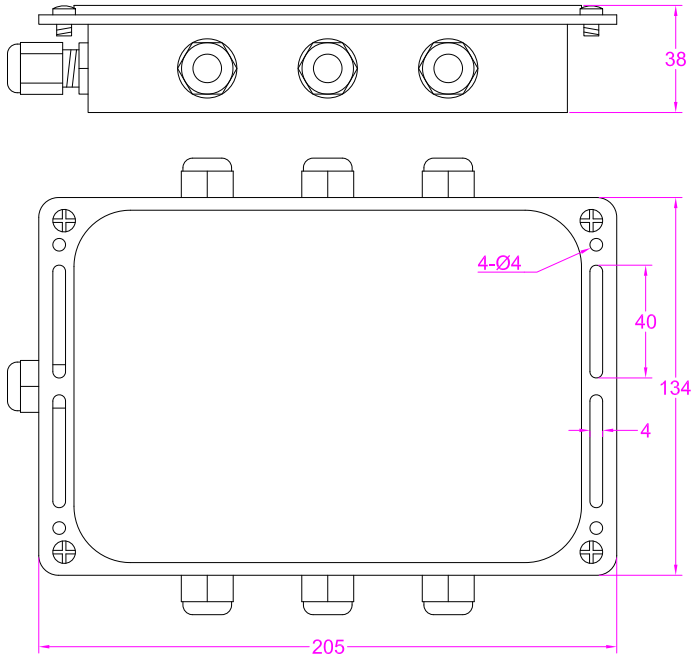

- Stainless steel enclosure
- Applicable cable diameter Ø3.5~Ø6.5
- Net weight: 682g
- IP65 protection
- Signal trimming for up to 6 load cells

Internal view

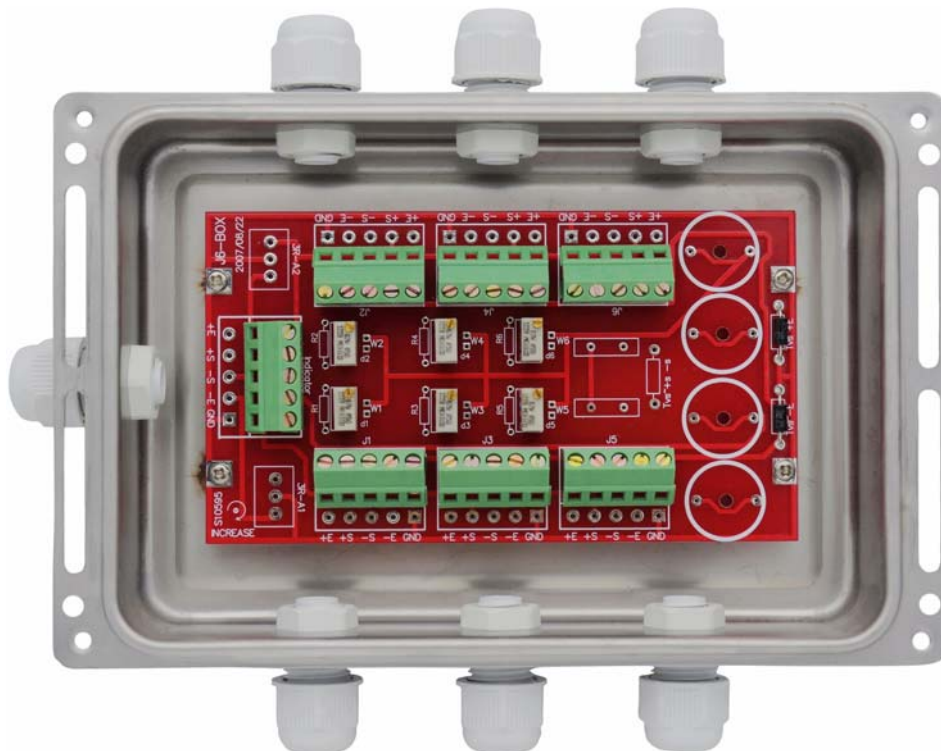

- Clip terminals J1~J6 are for load cell connection
- Potentiometers W1~W6 are for signal trimming
- Terminal indicator is for indicator connection
- +E ---- Excitation(+)
- E ---- Excitation(-)
- +S ---- Signal(+)
- S ---- Signal(-)
- GND ---- Shield